

KOHLER® Faucets Rite-Temp™ bath and shower trim kit with push-button diverter, 1.75 gpm Honesty™ K-T99763-4G

Features

- Includes lever handle, single-function showerhead, shower arm and flange, valve trim, and nondiverter bathtub spout with NPT or slip-fit connection
- Single lever handle allows for both on/off activation and temperature setting
- Rite-Temp™ pressure-balancing technology maintains water temperature within +/- 3°F
- Integrated push-button diverter
- 1.75 gpm (6.6 lpm) showerhead with Katalyst™ air-induction technology

Material

- Premium material construction for durability and reliability
- KOHLER finishes resist corrosion and tarnishing

Installation

- Trim only; requires K-11748-K or K-11748-KS Rite-Temp pressure-balancing valve (sold separately)

Adapters, Rough-in and Extension Kits

1226074-*

Range: 3-1/2" (89 mm) -
4-1/4" (108 mm)



Codes/Standards

ASME A112.18.1/CSA B125.1
DOE - Energy Policy Act 1992
EPA WaterSense™
California Energy Commission (CEC)

KOHLER® Faucet Lifetime Limited Warranty

See website for detailed warranty information.

Available Colors/Finishes

Color tiles intended for reference only.

Color	Code	Description
	CP	Polished Chrome
	BN	Vibrant™ Brushed Nickel
	BL	Matte Black
	2MB	Vibrant™ Brushed Moderne Brass

1-800-4KOHLER (1-800-456-4537)

Kohler Co. reserves the right to make revisions without notice to product specifications.

For the most current Specification Sheet, go to www.kohler.com.

4-2-2023 22:38 - US/CA

THE BOLD LOOK
OF **KOHLER**®

KOHLER Faucets Rite-Temp™ bath and shower trim kit with push-button diverter, 1.75 gpm K-T99763-4G

Honesty™
diverter, 1.75 gpm
K-T99763-4G

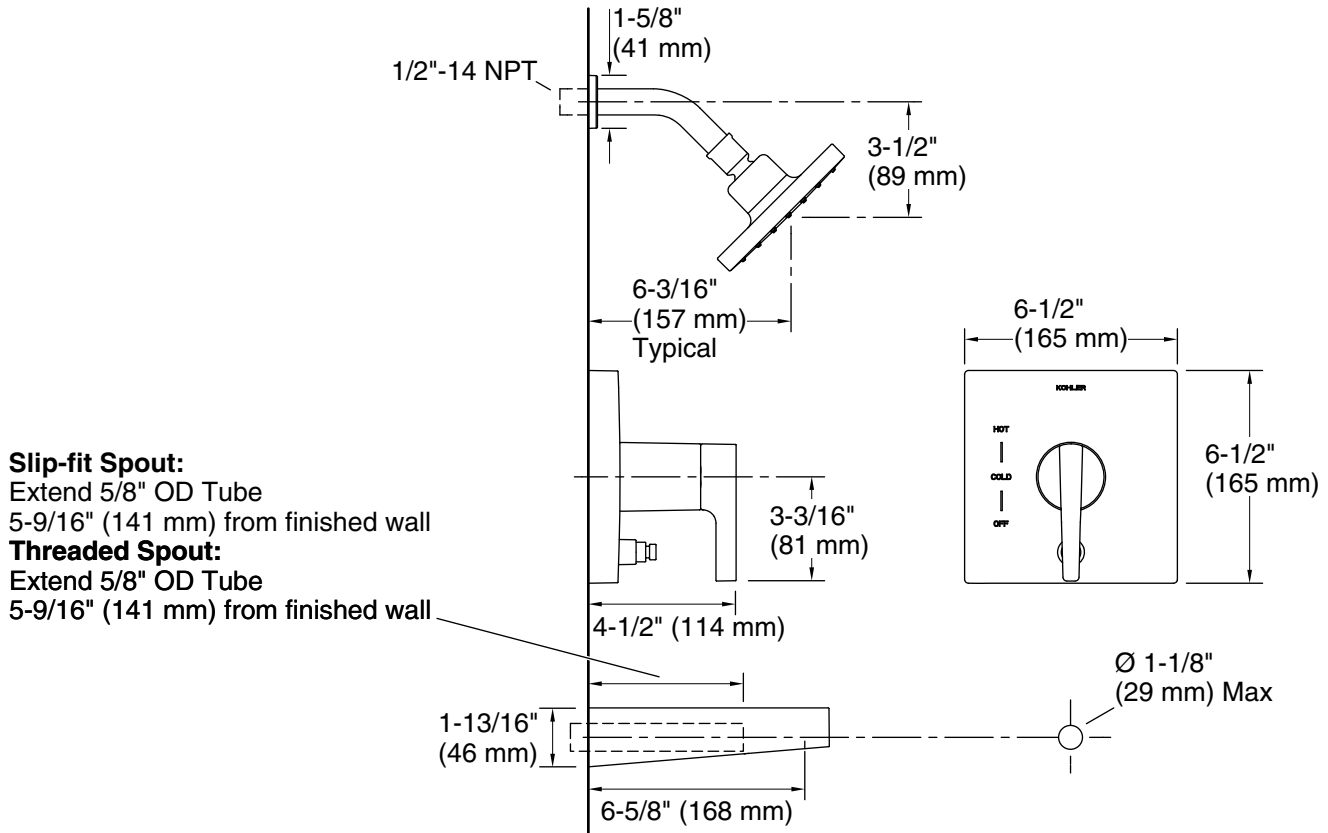

Technical Information

All product dimensions are nominal.

Drain included: No

Showerhead/Body Spray:

Rated maximum flow: 1.75 gal/min (6.6 l/min)

Pressure: 80 psi (5.5 bar)

Notes

For use with automatic compensating valves rated at 1.6 gal/min (6.1 l/min) or less.

Install this product according to the installation instructions.

Install straight pipe or tube drop of 7" (178 mm) to 18" (457 mm) with single elbow between the valve and the wall-mount spout.